

PRODUCT INFORMATION

THE
ULTIMATE™
4-STROKE OUTBOARD

DF225/250

FOUR STROKE ELECTRONIC FUEL INJECTION



NMMA
2003 Innovation
Award Winner



Way of Life!

Suzuki's Award Winning Technology

The product of unrivaled expertise and world class technology, Suzuki's four-stroke outboards have long been on the cutting edge of outboard performance winning acclaim and awards for their advanced technology, innovative ideas, and designs. We were the first to introduce a digital Electronic Fuel Injection four-stroke; an idea that allowed the DF60 and DF70 to receive further recognition from the International Marine Trades Exposition and Convention when they captured the IMTEC Innovation Award. We were the first to offer an oil bathed, self-adjusting timing chain in a four-stroke engine with performance-enhancing dual overhead cams and four valves per cylinder. This brought us recognition again, when our DF40 and DF50 received the IMTEC Innovation Award making Suzuki the first manufacturer to receive this distinguished award two years in a row, and also giving us our third IMTEC award, again an industry first. DF90/115 and DF140 were the first to offer an offset driveshaft with a two-stage cam drive system and two-stage gear reduction system, making them the most compact outboards in their class.



At its first showing at a special preview at the Miami International Boat Show, the DF250 captured the NMMA (National Marine Manufacturers Association) 2003 Innovation Award making this the fourth of six Innovation Award for Suzuki.

DF225 Cool White

DF250 Shadow Metallic Black / Cool White



Compact High Performance Engine

The DF225 and DF250 all utilize a 3.6-liter DOHC, 24-valve V6 engine that produces 225hp / 250hp in their respective configurations. At 3614cm³ these engines feature big displacement, but innovative design makes them light and the most compact outboards in their class. Key features shared by these powerful four-strokes include Suzuki's digital sequential electronic fuel injection controlled by a 32-bit onboard computer and Suzuki's offset driveshaft, which allows for the use of a larger prop. In addition to that, the DF225/250 utilizes multi-stage induction to provide low-end torque. And the DF250 has variable valve timing for even more low and midrange torque.

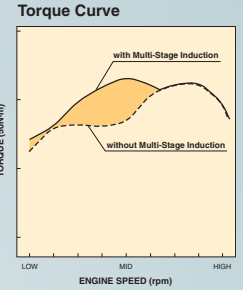

DOHC 24-Valve with VVT Delivers High Performance (DF250)

A high performance camshaft designed to deliver 250 hp produced the wanted power output, but to get the strong mid and low-end torque outboards need when accelerating requires altering valve timing. In general, only using a camshaft setting like those found in racing engines produces an engine that develops insufficient low and mid range torque. This is because the valve timing for intake and exhaust differs according to load and engine speed.

The common idea is that the intake valve opens after the exhaust valve is fully closed however, the intake valve actually starts opening before the exhaust valve fully closes, creating a momentary overlap in the timing where both valves are open. Using VVT (Variable Valve Timing) in the DF250, this overlap can be increased or decreased

Graph Illustrating the Variance in Valve Lift Using VVT

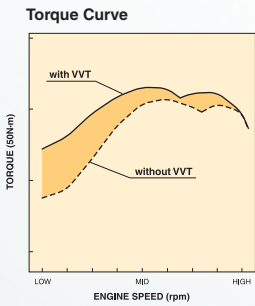
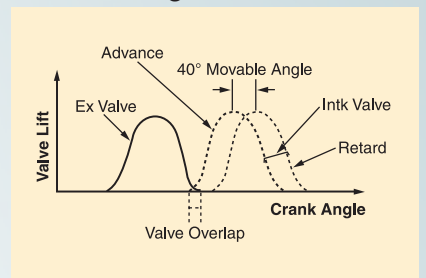

by altering intake timing with the camshaft, thereby optimizing camshaft timing for low range and mid range operation. As the DF250's camshaft is already setup to deliver maximum output at high rpm, a change in timing in this range is mostly unnecessary. Increasing the overlap is necessary during acceleration in the low and mid power range, but no change in timing is required for stable idling.

In the DF250's VVT system there are two chambers within the VVT actuator, one on the phase angle forward side and another on the phase angle backward side, to which hydraulic pressure is continuously applied to change the valve timing of the intake cam. When the engine is stopped, idling or other times that there is no oil pressure in the system, the VVT actuator locks, disengaging the system.

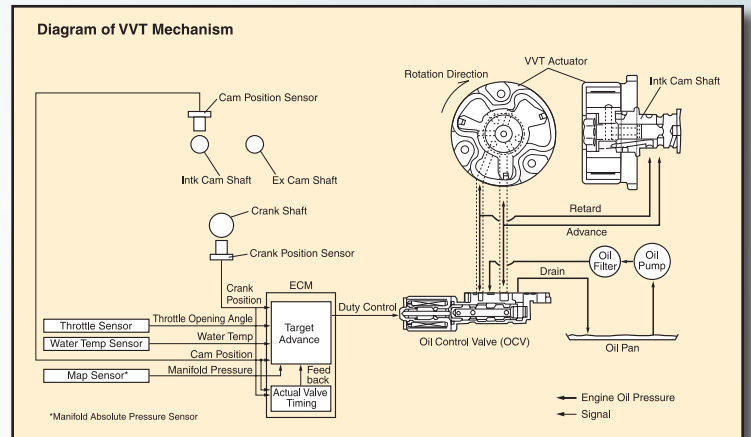

Multi-Stage Induction (DF225/250)

The DF225/250 utilizes multi-stage induction to enhance engine performance by changing the length of intake manifold pipes according to engine speed. The system utilizes two intake manifold pipes per cylinder, one operating at low engine speed and another operating at high. When the engine is operating at



Multi-Stage Induction Module

lower rpm, air enters the combustion chamber through the longer, curved manifold pipe. The length of the pipe is designed for entering the most suitable volume of fresh air into the chamber to improve combustion and boost low-end torque.

As rpm pass a preset threshold, the direct intake pipe opens up letting air enter directly into the combustion chamber. Short, straight and lacking resistance it gets a greater volume of air into the chamber, increasing the engine's ability to breathe at high rpm, thus improving high speed power output.

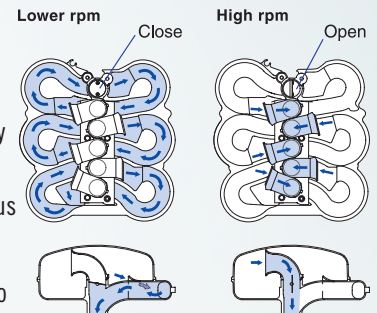

The engine cover is also designed with a large air intake, which extends to both sides to provide maximum airflow into the cowling.

Two-Stage Gear Reduction

With such a high performance engine now at our disposal, losing any power in the propulsion system would be a waste, so our engineers chose an efficient means of supplying maximum propulsion. A propeller rotating at high speed in the water has a tendency to slip and when two propellers of the same pitch but different diameters are rotated, the smaller propeller will slip more than the larger. So to obtain maximum propulsion, spinning a larger diameter propeller with a suitable pitch is the answer.

But to spin a larger propeller, more torque in the propeller shaft becomes necessary. In order to obtain the required amount of torque however, the corresponding increases in weight and resistance due to the use of larger gears and a larger gearbox do not always provide effective results. The answer to this dilemma is found in the use of a two-stage gear reduction system that provides the necessary torque without adding unwanted bulk and weight.

The DF225/250 utilize a first stage gear reduction (32:40) between the crankshaft and driveshaft, and a second stage reduction (12:22) in the lower unit's gear case, resulting in an overall gear ratio of 2.29. This is the largest gear reduction ratio found in any outboard over 200HP two-strokes included. Such a powerful reduction allows these outboards to turn a 16-inch diameter propeller. (14-1/2-inch diameter propeller found on the competition) For this reason, a propeller specially designed for greater acceleration and maximum speed is used on these 4-Stroke V-6 outboards. Along with providing greater acceleration, the gear reduction in combination with the four-stroke engine's wide power band is capable of handling a wide variety of loads, which is a significant benefit to boaters whose loads vary from day to day.

55-Degree Bank Angle Creates a Compact V6

One major design objective our engineers set out to realize was to produce a compact, narrow profile motor. This was met by abandoning the 60-degree bank angle normally utilized in V-type blocks and designing an all-new V-design block using a 55-degree bank angle—an industry first. When compared to the industry norm of 60-degrees, as shown in the engine cover comparison, the difference in size becomes quite clear.

Offset Driveshaft

Suzuki's utilization of an offset driveshaft has proven successful in reducing the size of the outboard. The DF225/250 benefit from this same design which positions the crankshaft in front of the drive shaft, simultaneously moving the outboard's center of gravity forward. This system adds to the compactness of the outboard and provides an improvement in power performance. It also places the engine's axis of inertia, the point where vibrations produced by the engine are at a minimum, up over the upper engine mount thus greatly reducing vibration.

Propeller Diameter Comparison

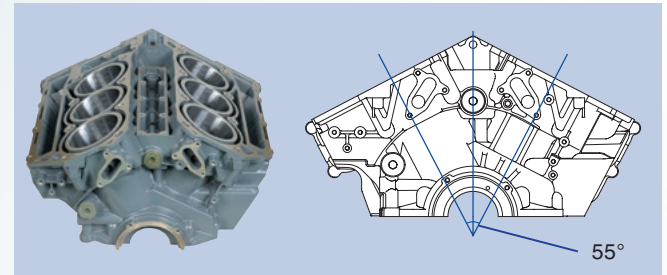
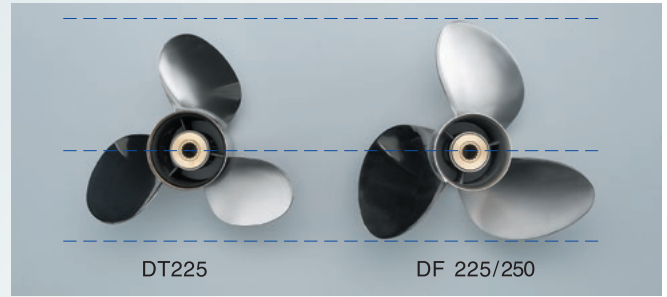

Cylinder Block

Engine Cover Profile Comparison

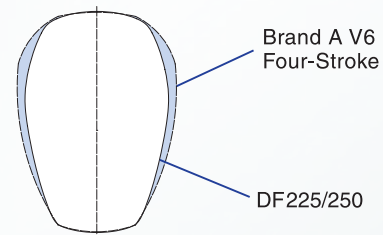

Offset Driveshaft

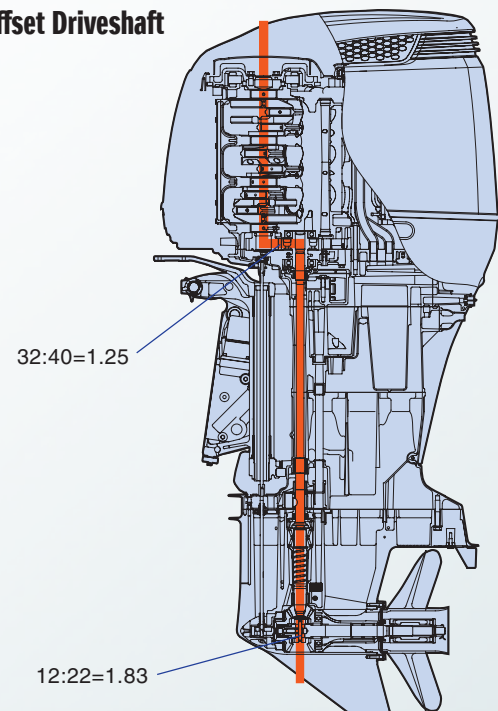

Two-Stage Cam Drive System

The two-stage cam drive system utilized in the DF225/250 incorporates both gears and a chain. The system's first stage gears transfer power between the crankshaft and the drive shaft (32:40) while the second stage utilizes a chain to deliver power from the drive shaft to the camshaft (20:32). This allows for the use of smaller diameter cam sprockets, which in turn allows for a reduction in valve angles also reducing the size of the cylinder head. The timing chain is equipped with an automatic hydraulic tensioner to keep the chain properly tensioned. This system provides years of maintenance-free operation.

Direct Ignition

An advanced direct ignition system used in both of these V6 outboards utilizes integral type spark plug caps with ignition coils. While reducing the number of parts and simplifying the wiring system, this arrangement also greatly reduces electronic engine "noise" that can interfere with VHF radios, fish finders and other marine electronics. Controlled by the outboard's powerful 32-bit computer this system provides each cylinder with optimum spark strength and timing.

DURABILITY AND RELIABILITY

Keeping The Engine and Components Cool

Fitted with fan blades the flywheel serves a dual purpose by efficiently expelling heat from within the engine cover out of the side of the cowl, keeping the temperature within the cowl under control.

Water circulating around the oil jacket located at the base of the V-bank cools oil flowing through the pipe, keeping oil temperature under control. This contributes to the cooling of the engine thereby enhancing durability.

The DF225/250 also utilize piston cooling jets, each of which shoots a stream of oil onto the underside of the piston to aid in cooling. Fine nozzles deliver a well-defined stream that is precise and accurate. The engines are also equipped with another cooling jet that shoots a stream of oil onto the main cam chain and drive gear to keep those components cool as well.

Suzuki Anti-Corrosion Finish

Suzuki has formulated a new anti-corrosion finish that both increases the durability of the engine and protects those parts of the aluminum exterior that are constantly exposed to saltwater. The Suzuki Anti-Corrosion Finish is a specially formulated advanced finish that offers maximum bonding of the finish to the aluminum surface for an effective treatment against corrosion. Since 2004, the Suzuki Anti-Corrosion Finish can be found on all four-stroke models from the DF9.9B and up.

Cam Drive System

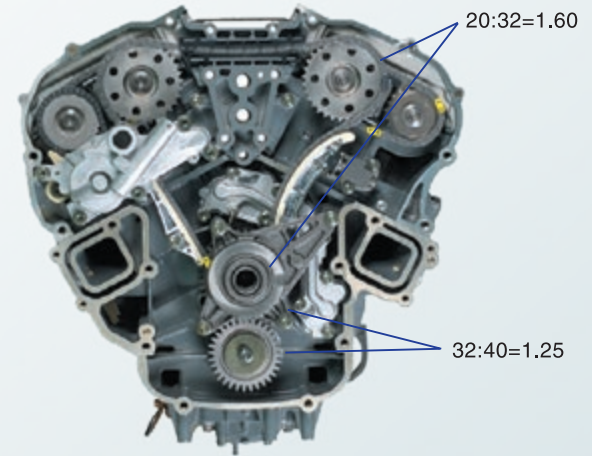

Plug Top Ignition Coil



Flywheel Magneto



Piston Cooling Jet

LOW EMISSIONS

Multi Point Electronic Fuel Injection

As Suzuki was the first in the industry to incorporate multi point electronic fuel injection in a four-stroke outboard with the DF60 and DF70, it is only natural that the DF225/250 would incorporate the same. Along with Suzuki's Multi Point Sequential Fuel Injection, the DF225/250 incorporate an ECM (Engine Control Module) which constantly monitors crucial data, in real time, from a series of sensors placed in critical areas on the engine. This comprehensive network of sensors includes the Manifold Absolute Pressure Sensor, Crankshaft Position Sensor, Intake Air Temperature Sensor, Cylinder Wall Temperature Sensor, Camshaft Position Sensor and Exhaust Jacket Temperature Sensor. To process all of this data efficiently, the ECM relies on a powerful 32-bit computer which instantly



Injector & Manifold Module

calculates the optimum amount of fuel to be injected at high pressure into each of the cylinders by the Multi Point Sequential Fuel Injection system. This system greatly reduces exhaust emissions allowing the DF225/250 to comply with both the 2010 EPA* regulations and CARB** Three Star Ultra Low Emission Standard, the strictest exhaust regulations to date, while providing lower fuel consumption, smooth starts, crisp acceleration, smooth performance and maximum efficiency.

CARB 3 Star

The DF225/250 have received the CARB three-star rating which identifies engines that meet the California Air Resources Board's Ultra Low exhaust emission standards. The most stringent exhaust emission requirements for outboard motors.

- * Exhaust emission standards set by the U.S. Environmental Protection Agency.
- ** Exhaust emission standards set by the California Air Resources Board.



Multi Point Sequential Electronic Fuel Injection

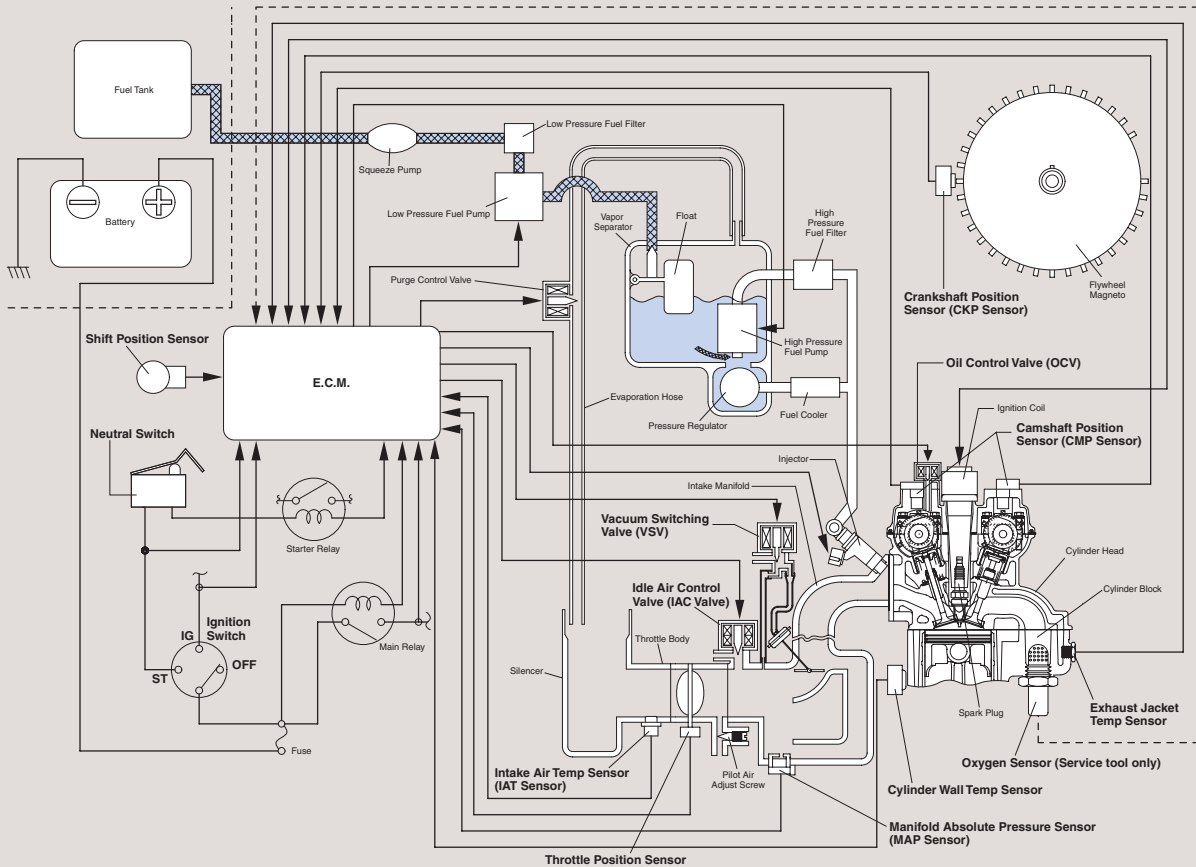

CONVENIENT FUNCTION

High Output Alternator

The DF225/250 are equipped with a high output alternator that delivers 54 A(12V) of electrical power. Designed to produce a majority of this power at low rpm, around 38 A is delivered even at 1,000rpm. It delivers a generous amount of current to keep an assortment of electronics up and running.

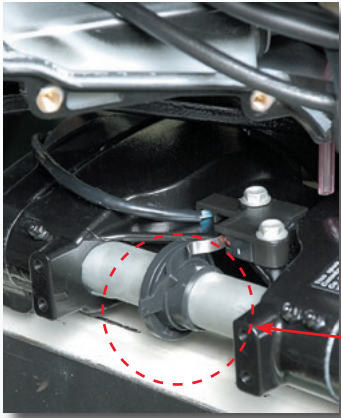

Tilt Limit Switch

The motor tilt system incorporates a user programmable tilt limit switch, which prevents the motor from tilting beyond a predetermined position. This can be used to protect both the boat and motor from damage that can occur when tilting the motor.

Tilt Limit System

Alternator Output

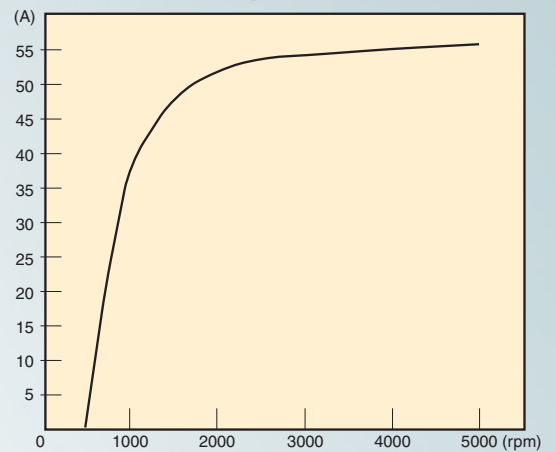

New Suzuki Water Detecting System

Water in the fuel can be the source of poor combustion, lower power output, and corrosion. To help protect the engine from moisture in the fuel, the DF225/250 utilizes a water detecting fuel filter that alerts the operator with both visual and audio warnings when water is present in the fuel.



Other Features

- Counter-rotation models are available for the DF225/250 in 25-inch transom lengths for compatibility with a wider range of offshore boats.
- Lower cover separates into two sections to allow easier access for maintenance to the V6 engine.
- An oil change reminder system, built into the Multi-Function Tachometer (Optional), informs the user with a flashing oil lamp when it is time to change the oil.
- Oil changes are easy with the oil drain plug located on the port side of the down housing, the oil filler cap on the top of the cylinder head, and a spin-on oil filter.
- A comprehensive monitoring system built into the Multi-Function Tachometer (Optional) detects abnormalities in the running of the outboard to provide information and alerts so that appropriate measures can be taken before the problem becomes serious.

Suzuki Motor Corporation

A tradition of Innovation

Suzuki history begins with the founding of Suzuki Loom Works by Michio Suzuki in October 1909. Realizing that weaver wanted to produce cloth both vertical and horizontal patterns, he developed an automated loom capable of weaving patterned cloth from space dyed yarn. His commitment to innovative engineering was the start of an uncompromising focus on creating products that meet people's needs and offer new life style possibilities.

While the company has evolved, diversified, and expanded since then, we have always honored our founder's commitment to innovative engineering. His philosophy lives on in the "Way of Life!" brand slogan and our dedication to provide our customers with value packed products that bring satisfaction and meet their needs.

Suzuki Motorcycles, ATVs & Scooters

Suzuki's full lineup of motorcycles, ATVs and scooters lead the industry with cutting-edge technology, convenient features, unrivaled performance and superior quality.

With a broad lineup that includes sportbikes, cruisers, motocross, dual-sport, adventure, scooters, ATVs and more – Suzuki has built its reputation on performance and innovation. Suzuki's motorcycles, ATVs and scooters have revolutionized the industry and redefined their categories. The rugged KingQuad ATV line celebrates 30 years as the "First on 4-Wheels." The legendary GSX-R line, which practically invented the modern sportbike when introduced in 1986, celebrates the unprecedented milestone of over 1 million units produced worldwide. Suzuki's other product lines, including Burgman scooters, Boulevard cruisers

and V-Strom adventure motorcycles, continue to innovate and set the industry-standard for performance, features, quality and value.

Suzuki Outboards

Ranging from the world's first 300 hp four-stroke outboard to the portable DF2.5, Suzuki offers a comprehensive lineup that represents state-of-the-art design and technology. These engines offer great fuel efficiency and environmentally responsible operation that meet many of the toughest emission standards – worldwide. In 2008 Suzuki introduced the first "New Generation" four-stroke outboard motors, the DF90A and DF70A, followed by the DF60A in 2009. 2010 was another big year with the introduction of the NMMA Innovation Award Winning (Sixth Time) DF50A/40A with Lean Burn and the redesigned

DF300A with Lean Burn. 2011 followed up with additional design changes for the DF300AP to include the NMMA Innovation Award Winning (Seventh Time) Select Rotation drive system. In 2012 Suzuki introduced the NMMA Innovation Award –Honorable Mention– DF20A/15A with Battery-less EFI/Lean Burn and the redesigned DF115A/DF140A with Lean Burn. In the same year, Suzuki also added the DF250AP with Lean Burn, Select Rotation and Suzuki Precision Control. These outboards deliver clean running economical operation with Suzuki's Lean Burn Technology. At Suzuki, our goal is to build outboards that

are highly efficient, deliver low fuel consumption and high power output while placing less stress on the environment.

Suzuki Motorsports

On the track, Suzuki has captured major championships around the world. The experience, knowledge and expertise gained on the track produces race proven, leading edge technologies that are utilized in every vehicle we make. Suzuki supplies you with the best combination of performance, durability, reliability, efficiency, ease-of-use, and value. It's why Champions Choose Suzuki. So, what are you gonna ride?

To learn more about Suzuki, visit your local Suzuki dealer or go to

www.suzuki.com



DF225/250 SPECIFICATIONS

MODELS	DF225	DF250
ENGINE TYPE	Four-stroke DOHC 16 valve	
TRANSOM HEIGHT in.	X: 25	X: 25 XX: 30
WEIGHT (lbs.)	X: 580	X: 580 XX: 591
STARTING SYSTEM	Electric	
FUEL DELIVERY SYSTEM	Multi Point Sequential Electronic Fuel Injection	
NO. OF CYLINDERS	V6 (55-degree)	
DISPLACEMENT	220.5 cu. in. (3,614cc)	
BORE X STROKE in. (mm)	3.74 x 3.35 (95 x 85)	
MAXIMUM OUTPUT /rpm	225 hp / 5500 rpm	250 hp / 5800 rpm
FULL THROTTLE OPERATING RANGE rpm	5000-6000 rpm	5500-6100 rpm
STEERING	Remote	
OIL SUMP CAPACITY	8.5 qt. (8.0 ltr)	
IGNITION SYSTEM	Solid State Direct Ignition	
ALTERNATOR	12V 54A/3000 rpm	
TRIM METHOD	Power Trim and Tilt	
GEAR RATIO	2.29:1 (Two-Stage Gear Reduction)	
GEAR SHIFT	F-N-R	
EXHAUST	Through Prop Hub Exhaust	
PROPELLER SIZE	3 x 16 x 17	3 x 16 x 23
OPTIONAL	3 x 16 x 18 1/2 3 x 16 x 20 3 x 16 x 21 1/2	3 x 16 x 24 1/2 3 x 16 x 26
BODY COLOR	Cool White	Shadow Metallic Black / Cool White

DF225/250 FEATURES

- V-design Engine Block using a 55-degree Bank Angle
- DOHC 24-valve Engine
- Variable Valve Timing (DF250)
- Multi-Stage Induction (DF225/250)
- Multi Point Sequential Electronic Fuel Injection
- Direct Ignition
- Offset Driveshaft
- Two-stage Gear Reduction
- Two-stage Camshaft Drive System
- Flywheel Designed with Fan Blades
- 54A Alternator
- Counter Rotation Models Available
- Tilt Limit Switch
- Oil Change Reminder System
- Low Oil Pressure Caution
- Over-Rev Limiter
- Overheat Cooling Water Caution
- Self Diagnostic System
- Neutral rpm Limiter
- Anti-Corrosion Protection
- Freshwater Engine Flush Port
- Large 16-in. Diameter

* The weight of the motors are "Dry-Weight," not including propeller.

* Boats and motors come in a large variety of combinations. See your authorized dealer for correct propeller selection to meet recommended RPM range at W.O.T.

Please read your owner's manual carefully. Remember, boating and alcohol or other drugs don't mix. Always use a USCG-approved life jacket. Please operate your outboard safely and responsibly. Suzuki encourages you to operate your boat safely and with respect for the marine environment.

SUZUKI MOTOR CORPORATION reserves the right to change, without notice or obligation, equipment, specifications, colors, materials and other items to apply to local conditions. Each model may be discontinued without notice. Please inquire at your local dealer for details of any such changes.

Actual body colors may differ slightly from the colors in this brochure.



CARB THREE-STAR LABEL

The three-star label identifies engines that meet the California Air Resources Board's most stringent exhaust emission requirements for outboard motors.



EPA 2010 LABEL

Suzuki's four-stroke technology is compliant with EPA's stringent 2010 exhaust emission standards and 2010-later evaporative emission standards set by the U.S. Environmental Protection Agency.



SUZUKI MOTOR OF AMERICA, INC.
P.O. BOX 1100 BREA, CA 92822-1100
www.suzukimarine.com